

Next-Generation Energy Efficient Networks: Overview of the GreenTouch Consortium

Thierry E. Klein, PhD

Director, Bell Labs Research / Alcatel-Lucent
Chair, GreenTouch Core Routing and Switching Working Group

Outline

- The Big Picture: Energy in ICT and the Internet
- Traffic Growth and Technology Challenges
- The Energy Gap
- GreenTouch Consortium

US Energy Supply and Consumption

Supply

Consumption

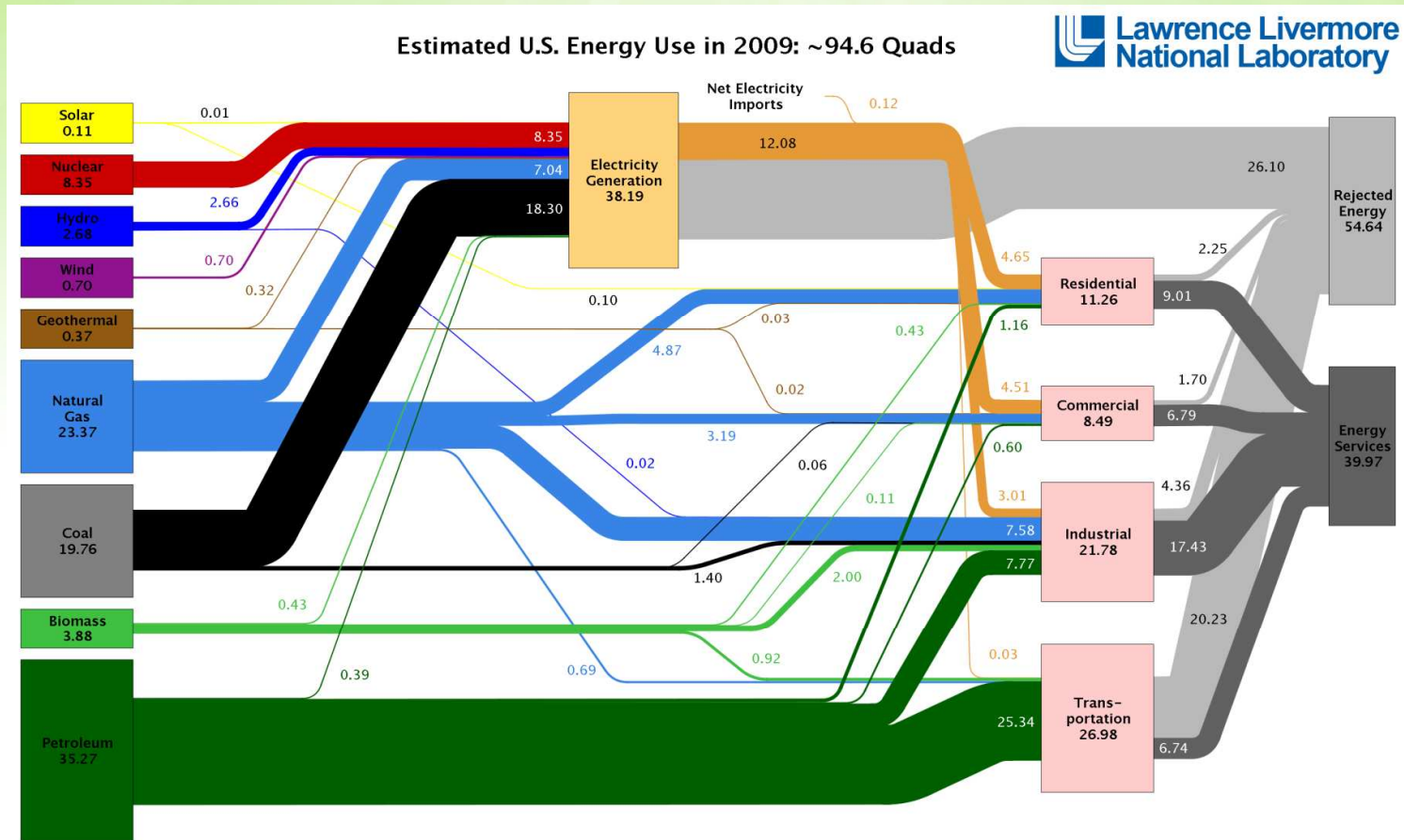

Most Energy is Lost!

Source: LLNL 2010. Data is based on DOE/EIA-0384(2009), August 2010. If this information or a reproduction of it is used, credit must be given to the Lawrence Livermore National Laboratory and the Department of Energy, under whose auspices the work was performed. Distributed electricity represents only retail electricity sales and does not include self-generation. EIA reports flows for non-thermal resources (i.e., hydro, wind and solar) in BTU-equivalent values by assuming a typical fossil fuel plant "heat rate." The efficiency of electricity production is calculated as the total retail electricity delivered divided by the primary energy input into electricity generation. End use efficiency is estimated as 80% for the residential, commercial and industrial sectors, and as 25% for the transportation sector. Totals may not equal sum of components due to independent rounding. LLNL-MI-410527

Quads (10^{15} BTUs)

World Greenhouse Gas Emissions (yr 2005)

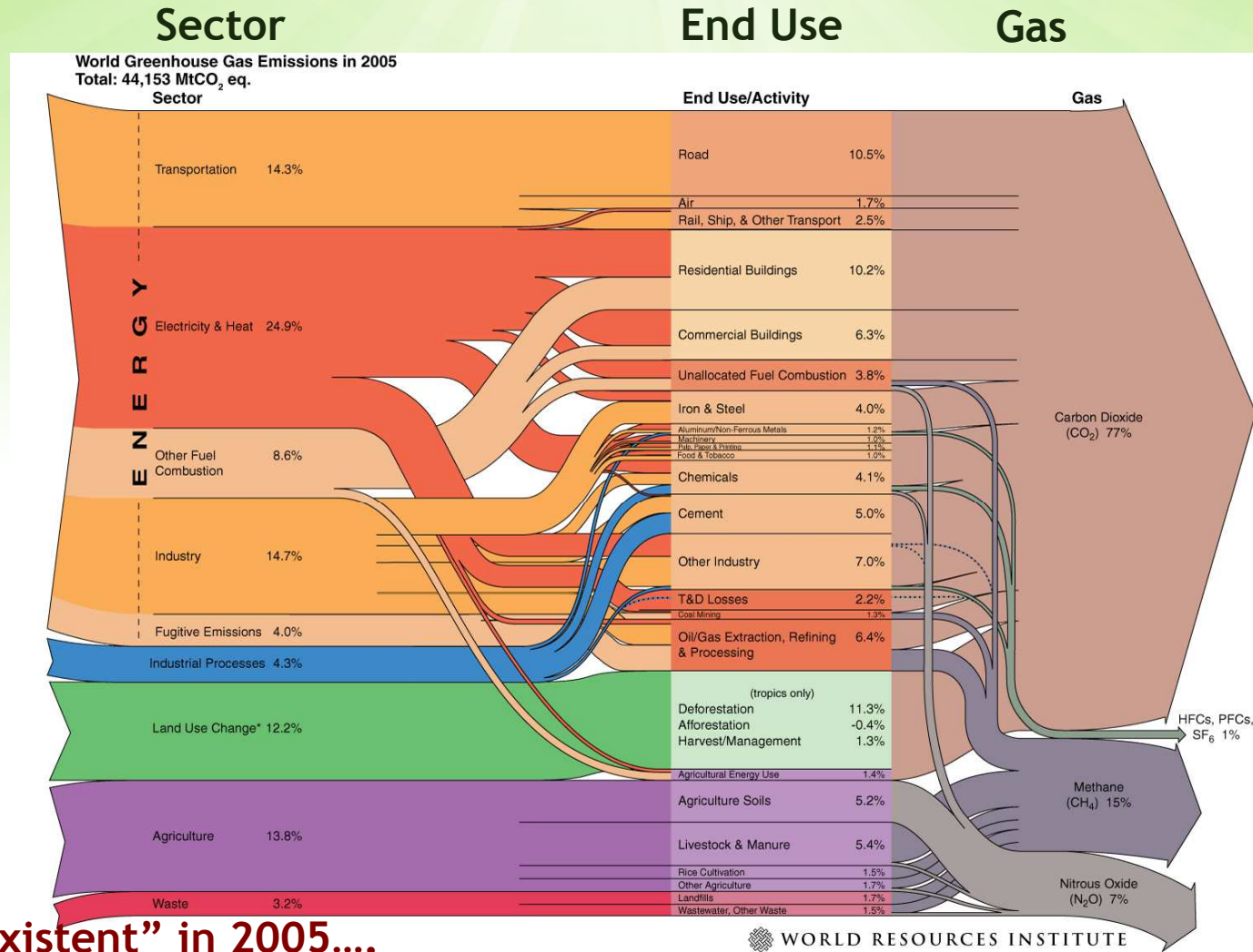

ICT “nonexistent” in 2005....

2020 ICT Carbon Footprint

820m tons CO₂

2007 Worldwide ICT carbon footprint:
2% = 830 m tons CO₂
Comparable to the global aviation industry

Expected to grow to 4% by 2020

PCs, peripherals and printers
57%



Telecoms infrastructure and devices
25%

Source: The Climate Group

Data centres
18%

360m tons CO₂

260m tons CO₂

Total emissions: 1.43bn tonnes CO₂ equivalent

The Climate Group, GeSI report
"Smart 2020", 2008

ICT: A Problem and The Solution

ICT today: 2% of global emissions...
with an opportunity to make tremendous impact on the remaining 98%

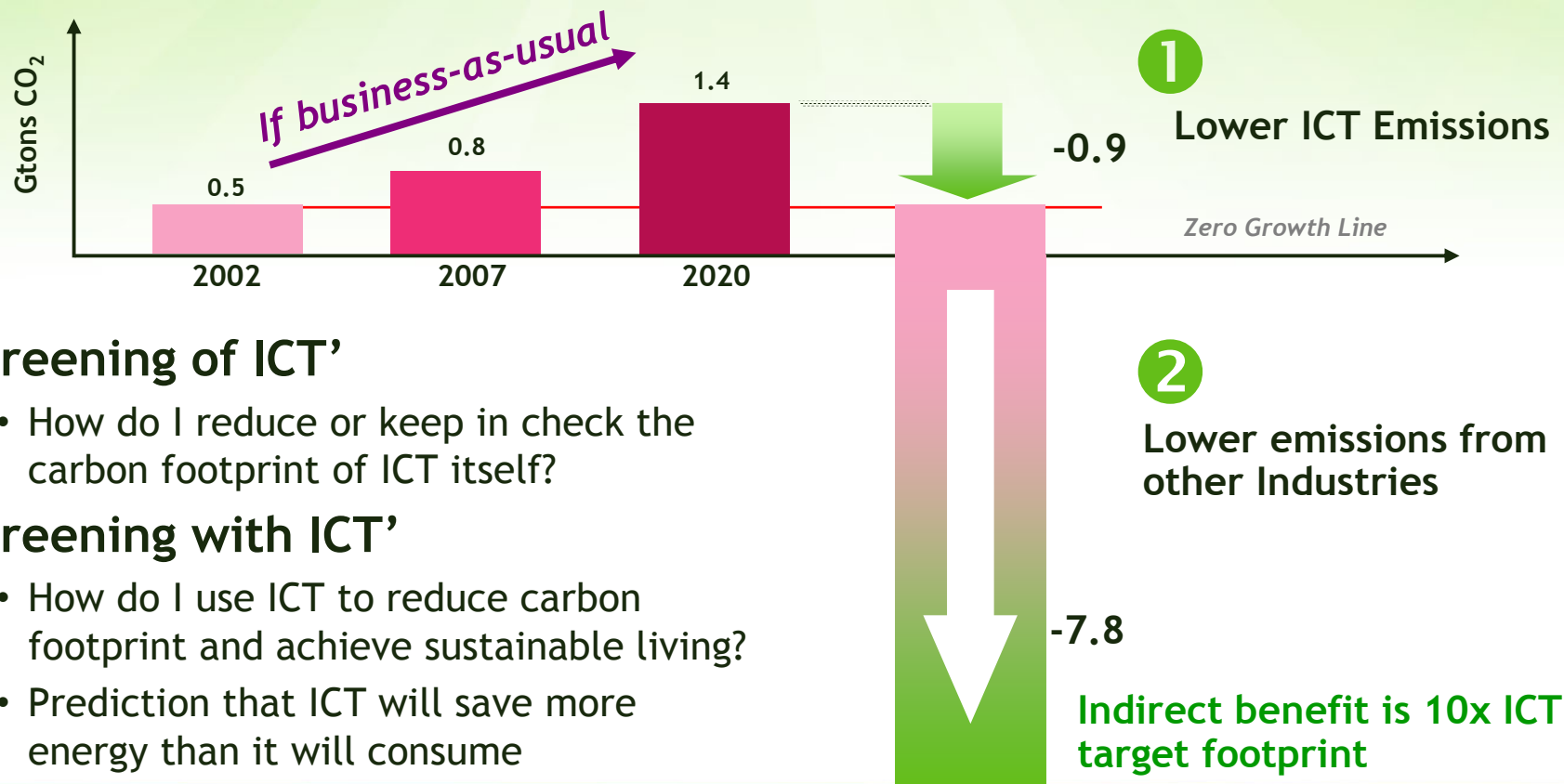

■ 'Greening of ICT'

- How do I reduce or keep in check the carbon footprint of ICT itself?

■ 'Greening with ICT'

- How do I use ICT to reduce carbon footprint and achieve sustainable living?
- Prediction that ICT will save more energy than it will consume

Source: GeSI - SMART 2020: Enabling the Low Carbon Economy in the Information Age

Past and Anticipated Internet Growth

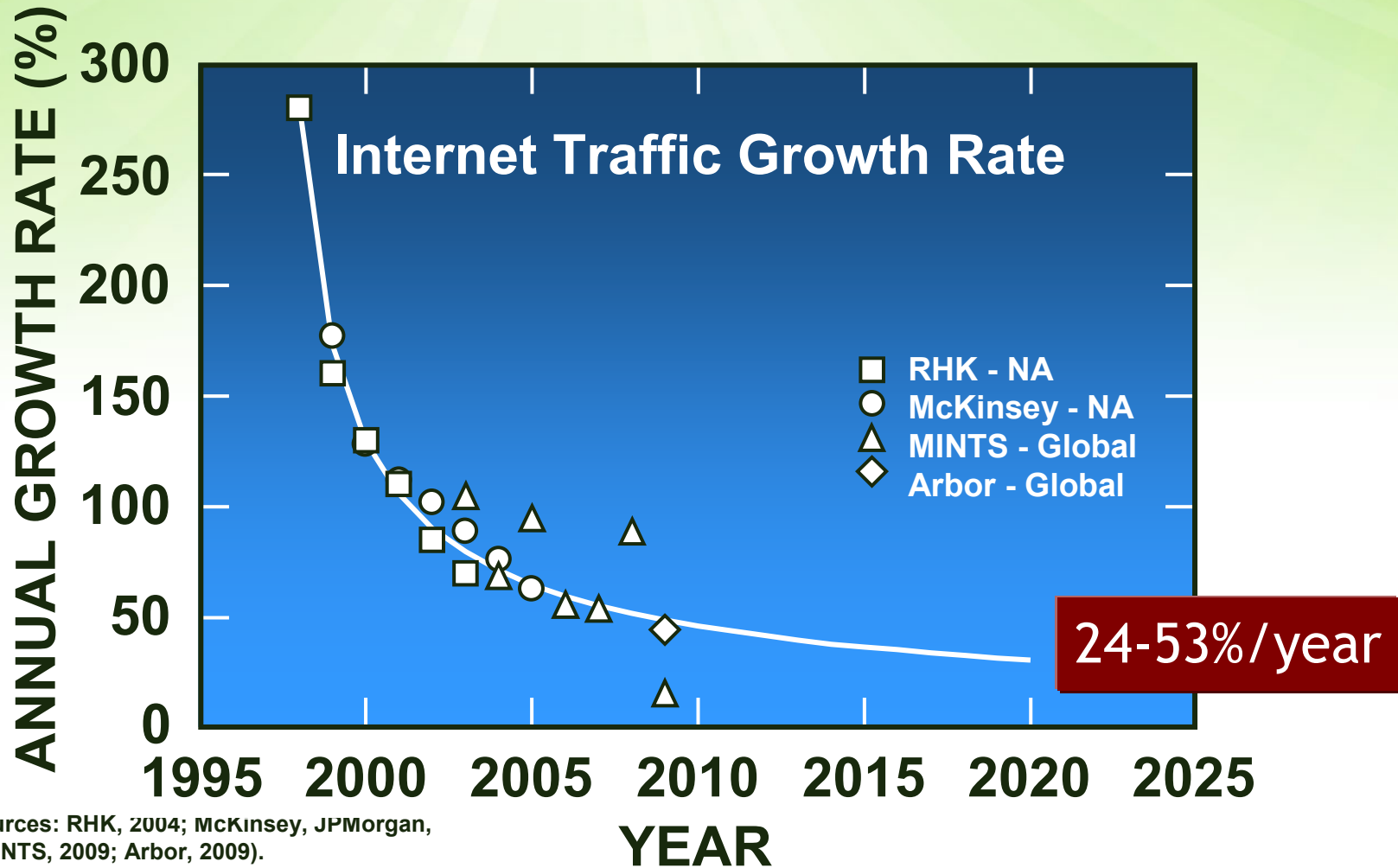

SKK, 2010 (Sources: RHK, 2004; McKinsey, JPMorgan, AT&T, 2001; MINTS, 2009; Arbor, 2009).

Continued Exponential Traffic Growth

North America

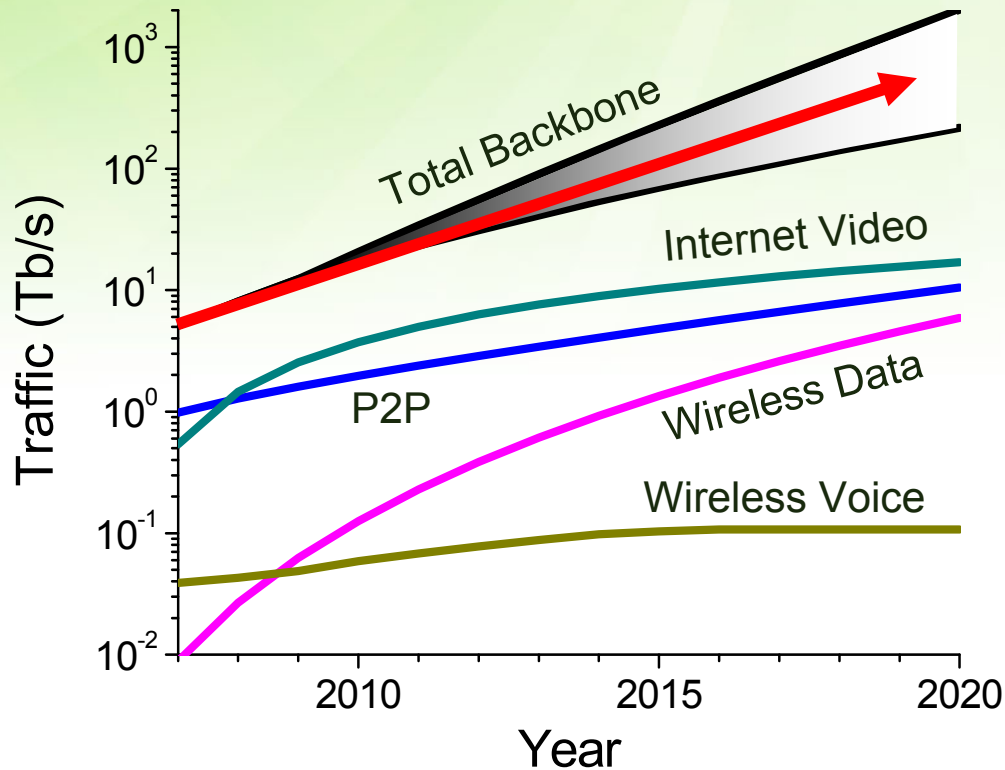

Data from: RHK, McKinsey-JPMorgan, AT&T, MINTS, Arbor, ALU, and Bell Labs Analysis: Linear regression on $\log(\text{traffic growth rate})$ versus $\log(\text{time})$ with Bayesian learning to compute uncertainty

Traffic doubling every 2 years

- 40% per year
- 30x in 10 years
- **1000x in 20 years**

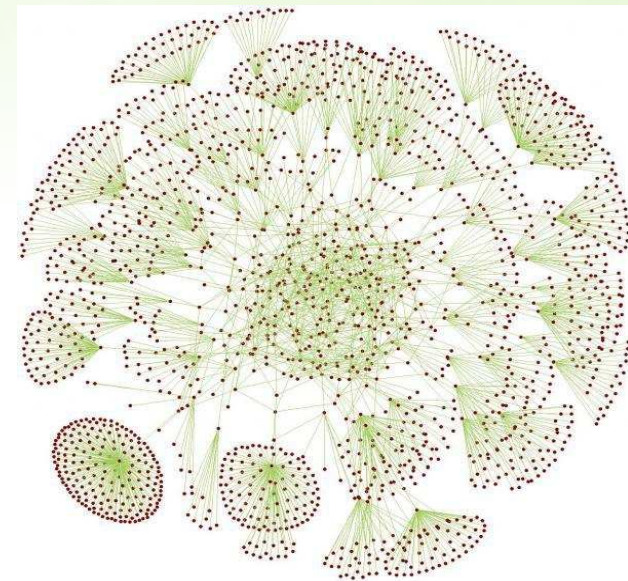

Network energy efficiency increasing 10-15%/year

Slowdown In Technology

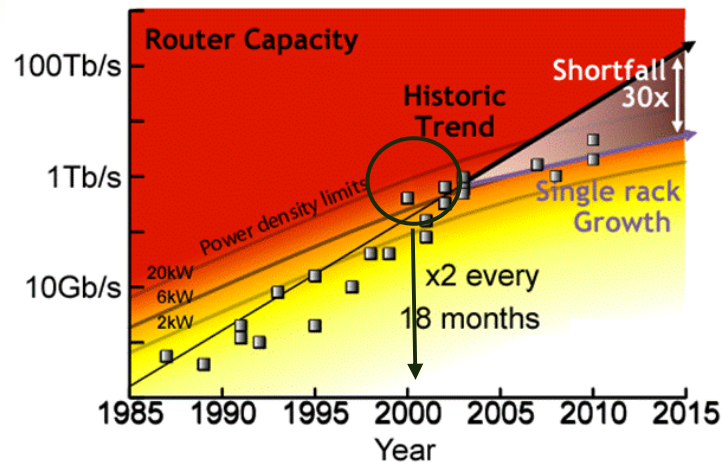
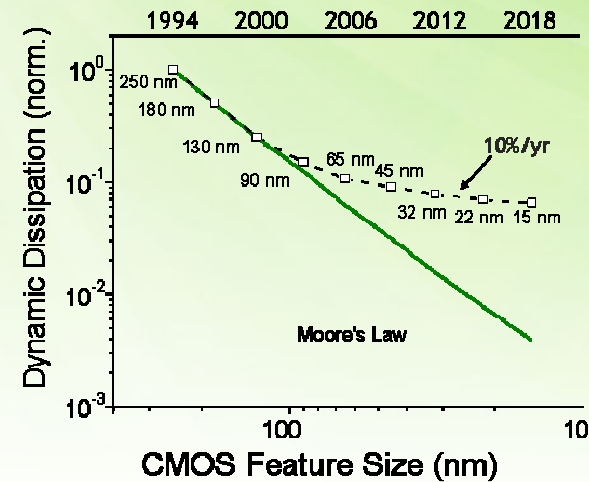
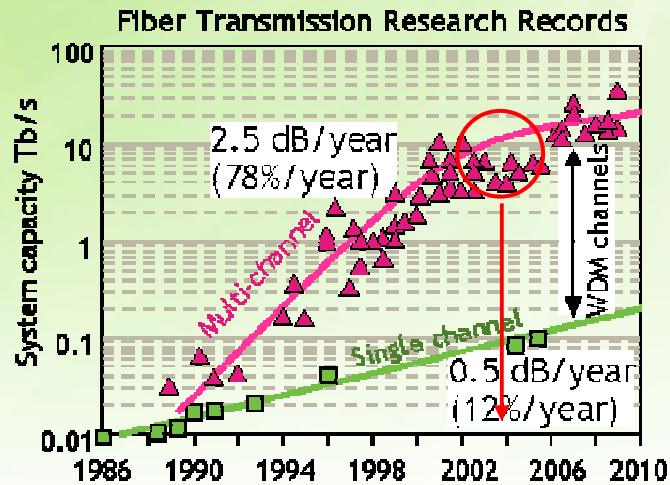

Interconnect power will dominate future router system power dissipation.

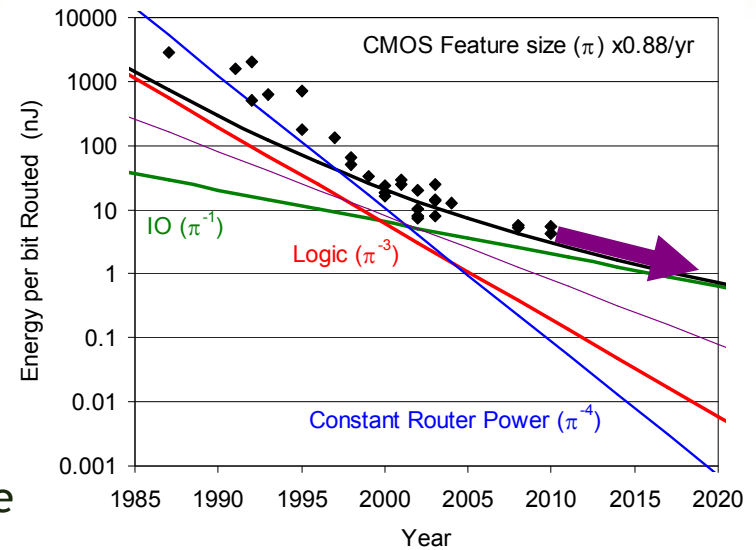

Tightening Energy Bottleneck

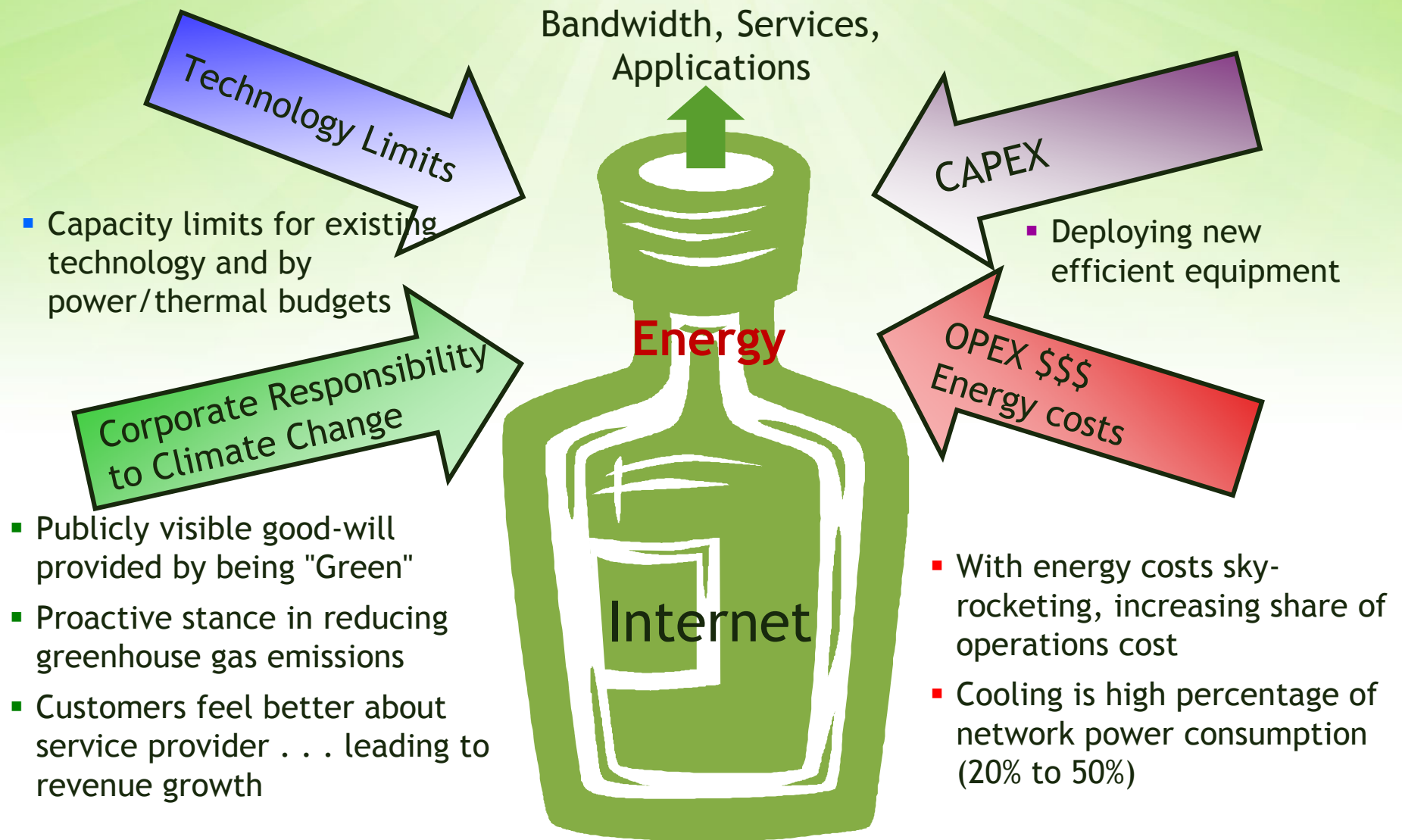

The Network Energy Gap

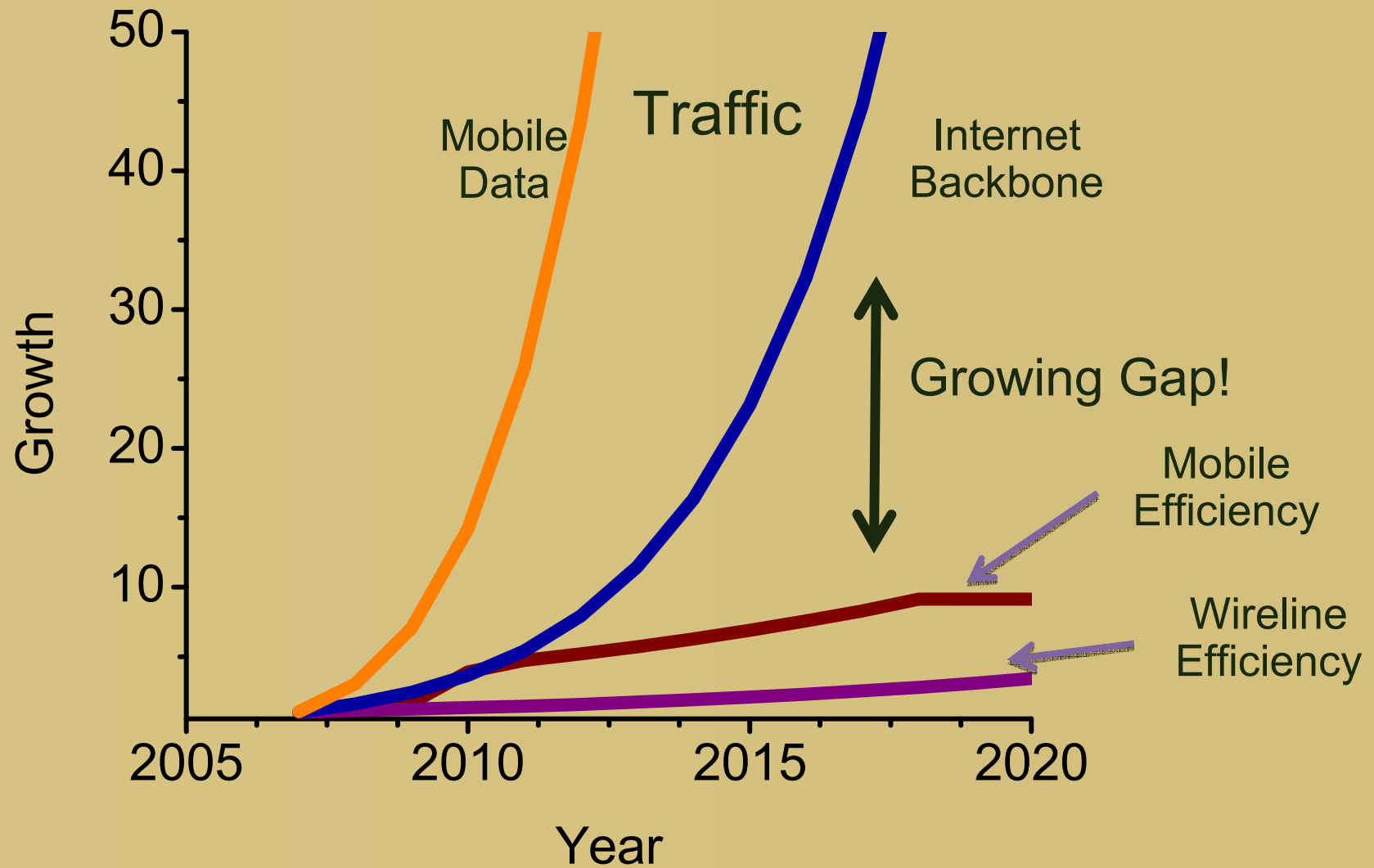

Baseline Business-As-Usual Trends

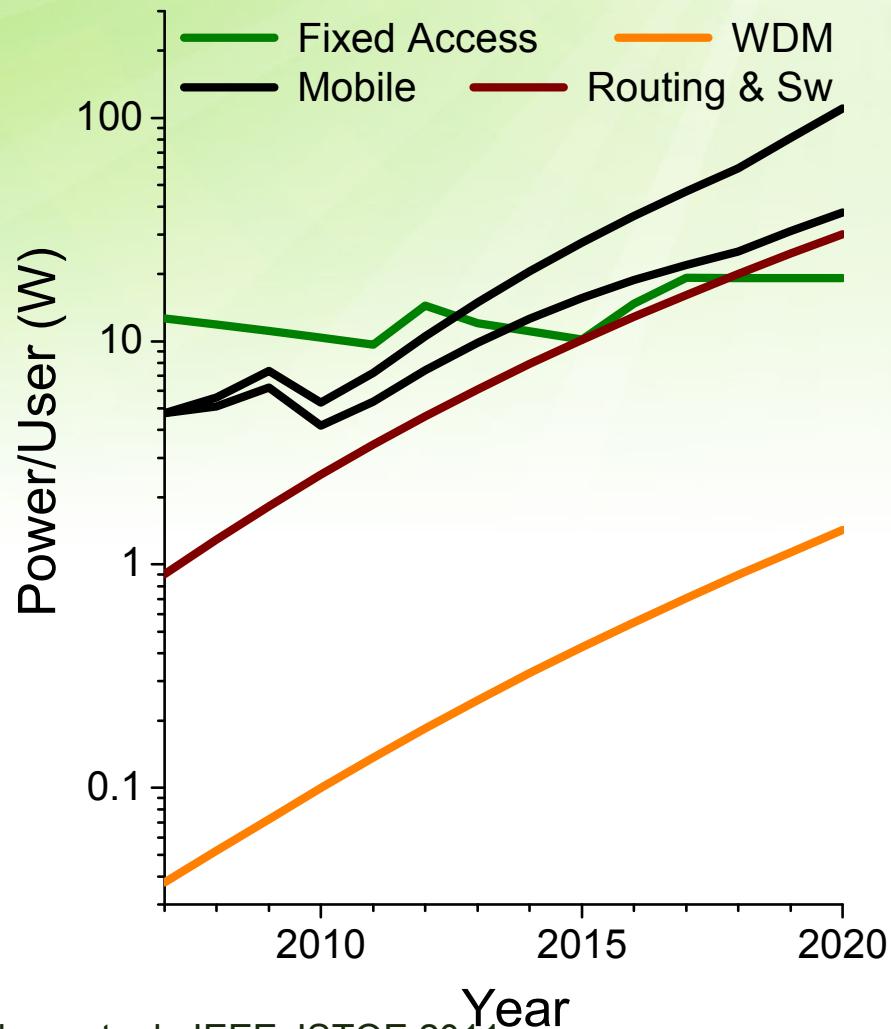

Kilper, et. al., IEEE JSTQE 2011

- State-of-the-art technology evolution
 - Mix of legacy equipment makes picture worse
- Mobile data is rapidly growing problem today
- Historical energy distribution from edge to core changes over next decade
- Includes 10%/year from Moore's Law
- Traffic growth: >30%/year
- Equipment efficiency: 10%-20%/year

Best Case Efficiency Improvements

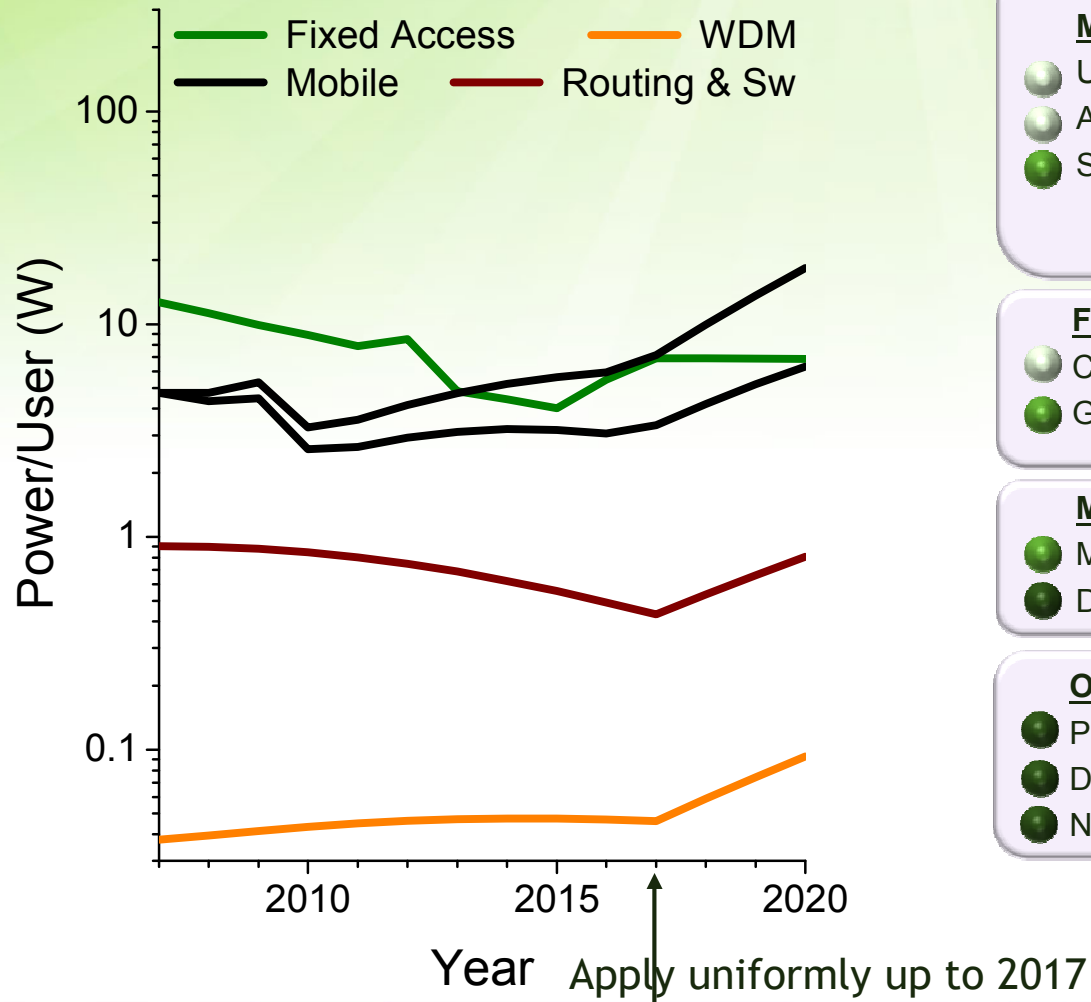

Mobile Access:

- Ultra-efficient power amplifiers (70%)
- Active antennas
- Self organizing networks

Fixed Access:

- Cost-reduced FTTH/N
- Green PON (from ~16W/user to ~5W/user)

Metro/Core:

- Mesh protection / fast restoration
- Dynamic Optical Bypass

Other:

- Passive cooling everywhere
- Dynamic energy usage (proportional to load)
- Network Virtualization

Degree of Difficulty:

● Lower
 ↑
 ↓
 ● Higher

Ideal Efficiency Improvements on BAU: Flat in 2020

Current technology will only sustain us for another decade:
how do we go beyond?

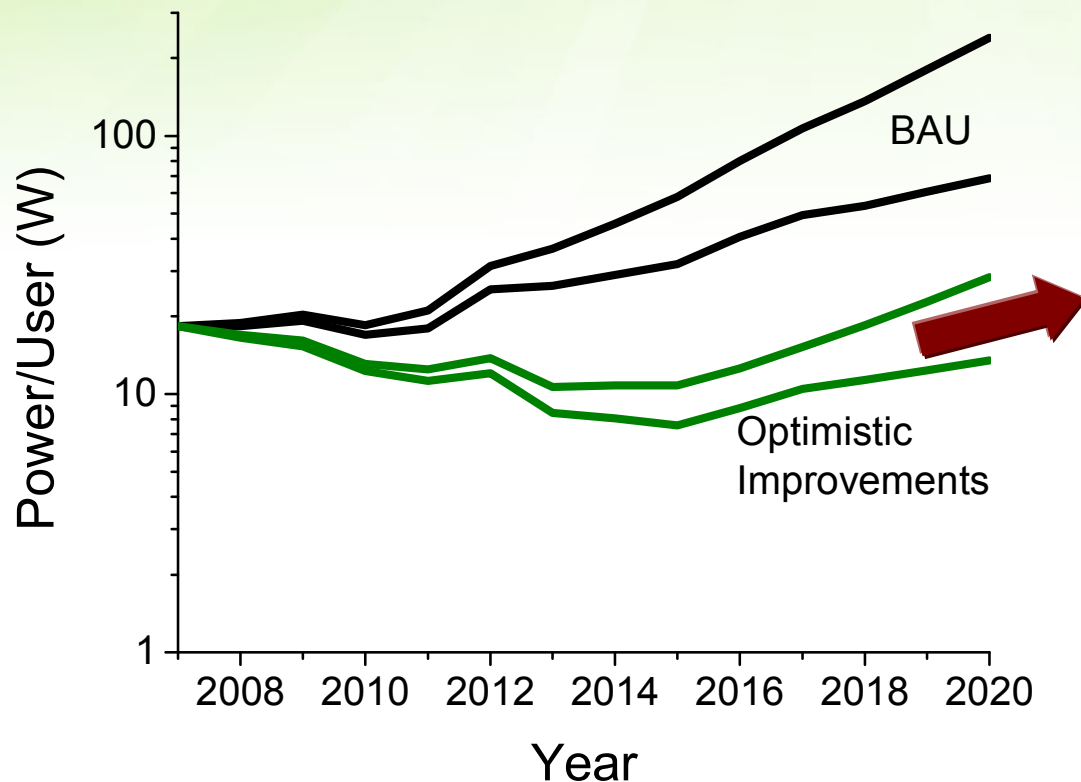

- Improving network efficiency at best keeps power consumption flat over next decade
 - What happens after 2020?
 - Can only use 'sleep modes' once

ICT Industry Responds

- **First Step: metrics, awareness, standards, call to action**
 - Global e-Sustainability Initiative (GeSI)
 - ITU-T
 - GreenGrid
- **Next Step: cooperation, action**
 - EARTH: LTE 2x
 - Mobile VCE: Green Radio 100x
 - Institute for Energy Efficiency: Wireless and optical 100x
 - GreenTouch: ICT Networks 1000x

GreenTouch Consortium

Broad, open and global consortium executing research projects to achieve aggressive goal

Forum for the exchange of information on energy trends, challenges, & research on communication networks

Roadmap organization establishing reference architectures, models and research targets to overcome major challenges facing network scaling and energy

Committed to open innovation and collaboration to accelerate progress

Members are experts from world's top institutions and operators

GreenTouch Mission

By 2015, our goal is to deliver the architecture, specifications and roadmap — and demonstrate key components and technologies — needed to increase network energy efficiency by a factor of 1000 from current levels.

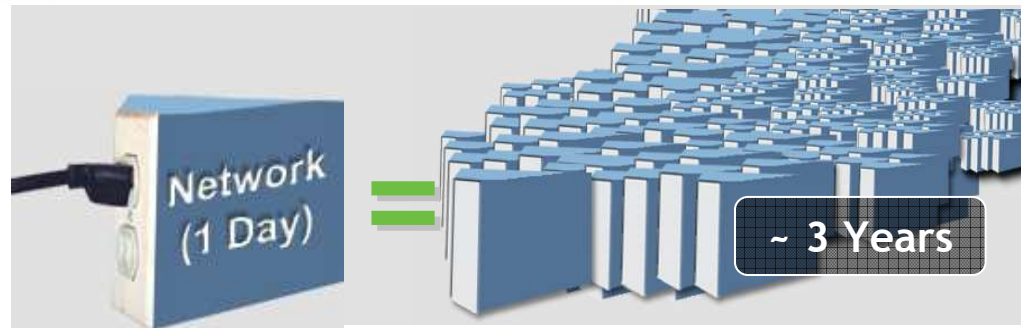
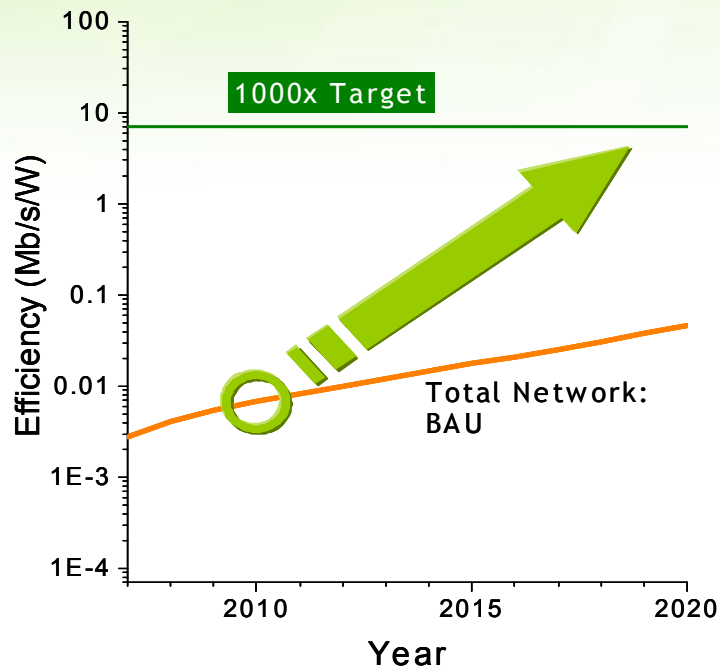

GreenTouch Members

- AT&T Services
- Athens Information Technology (AIT) Center for Research & Education
- Bell Labs, Alcatel-Lucent
- Broadcom
- Carnegie Mellon University
- CEA-LETI Applied Research Institute for Microelectronics
- China Mobile
- Chunghwa Telecom
- Columbia University
- Draka Communications
- Dublin City University
- Electronics and Telecommunication Research Institute (ETRI)
- Fondazione Politecnico di Milano
- Fraunhofer-Gesellschaft
- France Telecom
- Freescale Semiconductor
- Fujitsu
- Huawei
- IBBT
- IMEC
- INRIA
- KAIST
- Karlsruhe Institute of Technology
- Katholieke Universiteit Leuven (K.U. Leuven)
- King Abdulaziz City for Science and Technology
- KT Corporation
- National ICTA Australia
- Nippon Telegraph and Telephone Corp
- Politecnico di Torino
- Portugal Telecom Inovação, S.A.
- Samsung (SAIT)
- Seoul National University
- Swisscom
- TNO
- Tsinghua University
- TTI
- TU Dresden
- University College London
- University of Cambridge
- University of Delaware
- University of Maryland
- University of Leeds
- University of Melbourne's Institute for a Broadband-Enabled Society (IBES)
- University of New South Wales
- University of Toronto
- Waterford Institute of Technology

Primary Metric Is Network Energy Efficiency

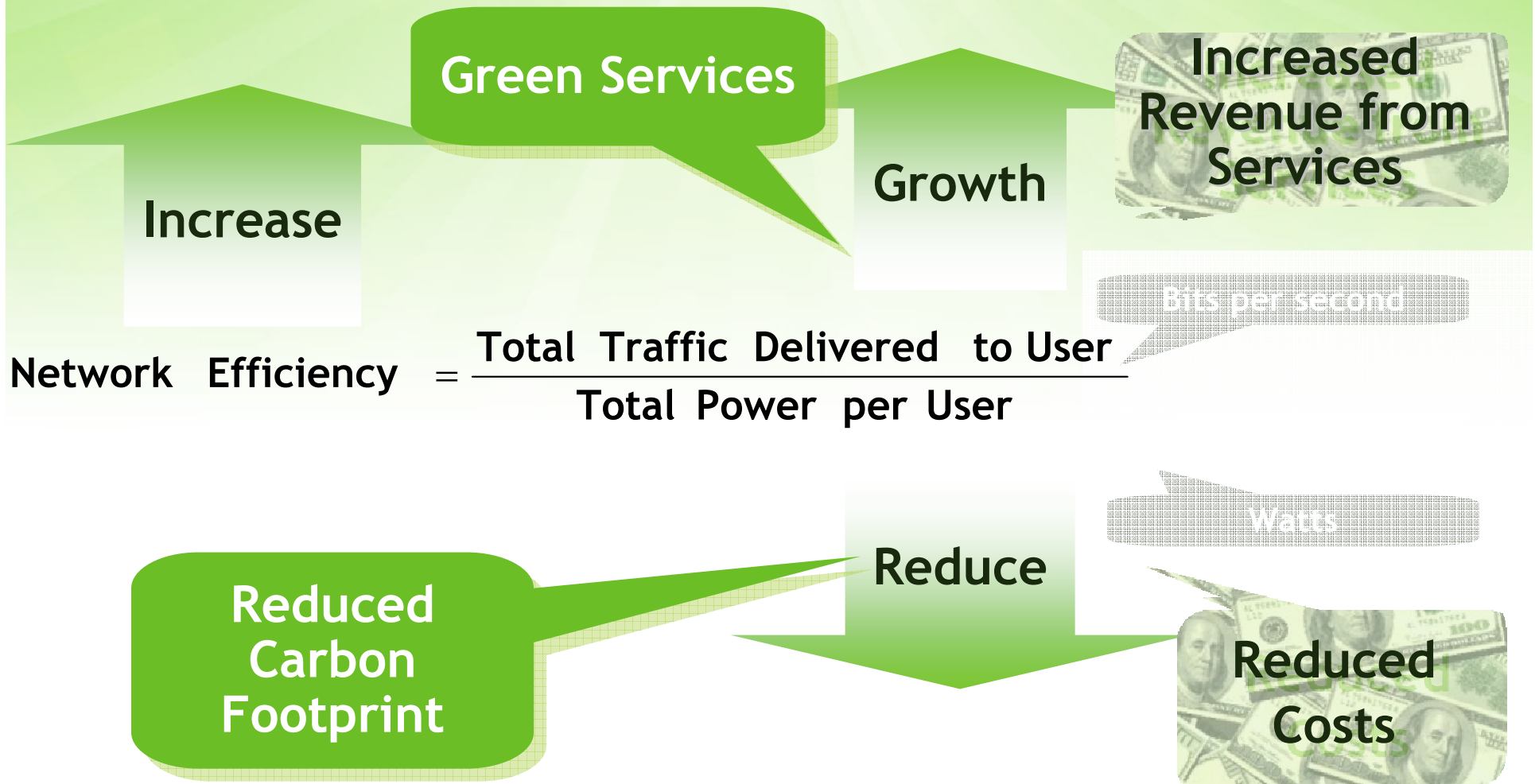

Makes both Environmental and Economic Sense

New Approaches: Focus On Energy

- New devices
 - Analog vs digital, best use of optics and electronics
 - Low power electronics and photonics
- New architectures
 - Trade-off transmission/bandwidth and processing, distributed versus centralized
- New protocols
 - Longer packet sizes or no packets at all for certain applications
 - Eliminate unnecessary and redundant processing
- Service optimized networks
 - Move away from one size fits all—use most energy efficiency hardware for the service
 - Coordinate service delivery/applications with network hardware operation
- Restructuring layers, architectures, feature options
 - How much do we pay in energy for convenience? Duplicated functions (FEC)?
 - What technologies do we really need in order to support the essential capabilities?

Minimizing Processing

- Repetition
 - Unnecessary router hops
 - Inter-operator exchange
 - Multiple transmissions
- Remove processing from the data path
 - Separate control channel
- Focus on service
 - Content delivery vs. browsing vs messaging
- Push to the edges
 - FEC
 - Security, policy processing
- Simplified addressing
 - Geographic addressing/binary switching

Separate what is
needed from what
is convenience

A Scalable Internet: Holistic Re-Design

- Processing
 - New addressing—transparent data flow
 - End-to-End—security, FEC
- Back to the Future
 - Optimized hardware for given task: service differentiation
- How many layers do we need?
- How do protocols and algorithms impact hardware design?
- How do we unlock physical potential—small cells, efficient MIMO?
- What is the real energy cost for the features and functions supported in the network?

Initial Activities

- Build research program
- First technology demonstration spring 2011
- Establish common reference architecture
- Define primary research targets
- Establish expected trends on key metrics to 2020
- Provide international forum for cooperation and exchange of ideas on energy research topics

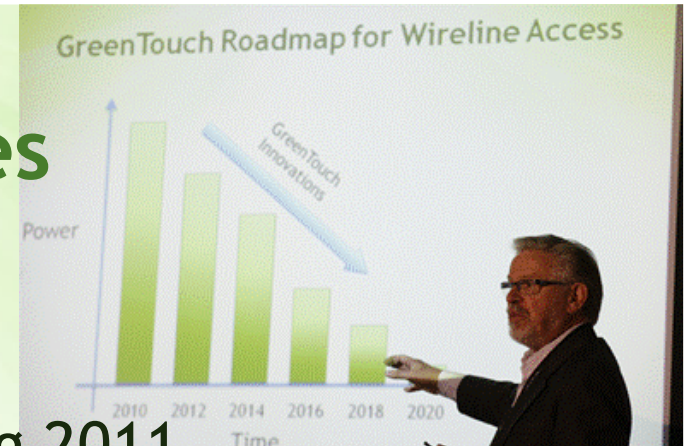

Some Research Projects...

Beyond Cellular - Green Mobile Networks
Virtual Home Gateway
Optimal End-to-End Resource Allocation
Service Energy Aware Optical Networks
Green Transmission Technologies
Minimum Energy Access Architectures
Single-Chip Linecards
Large-Scale Antenna Systems
Highly-Adaptive Layer Mesh Networks
Massive MIMO

Fondazione
Politecnico
di Milano

swisscom

UNIVERSITY OF LEEDS

COLUMBIA UNIVERSITY
IN THE CITY OF NEW YORK

HUAWEI

ceet
centre for
energy-efficient
telecommunications

Bell Labs

imec

Bell Labs

SAMSUNG
SAMSUNG ADVANCED
INSTITUTE OF TECHNOLOGY

25+
Projects
Active &
In Prep.

Roadmap Details Underway

GPON XGPON

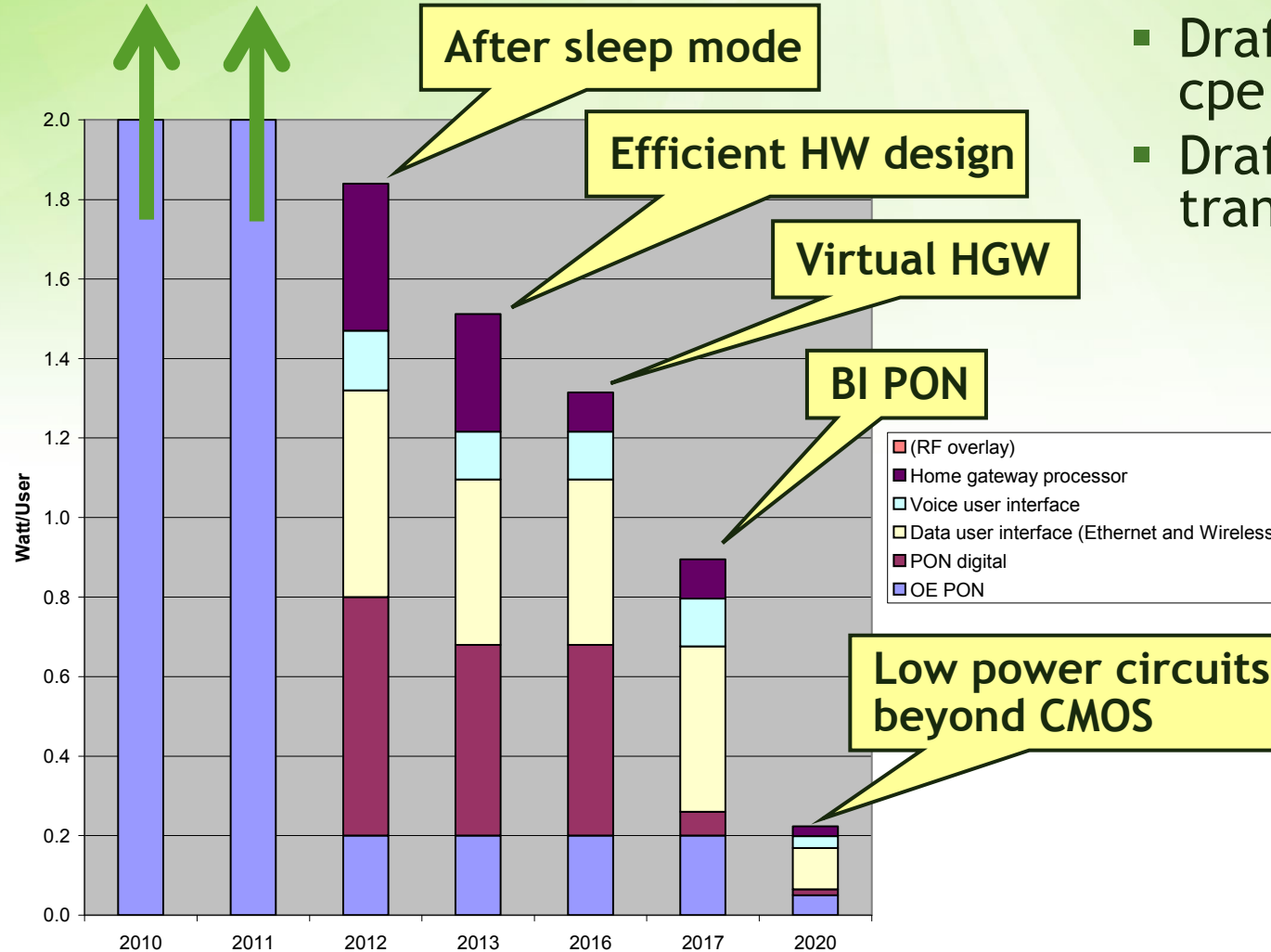

- Draft wireline access cpe trend
- Draft Core Opt Ntwk transponder model

Tx:	P(W)	Notes
Mux	0.40	10pJ/b
Driver	1.00	25pJ/b
Laser	0.06	1.5pJ/b
Mod	0.16	4pJ/b
Subtotal	1.62	
Rx:		
PhotoRx	0.144	3.6pJ/b
DeMux	0.80	20pJ/b
Subtotal	0.95	
	2.56W	20%
+Inefficiencies	10.25W	80%
P _{function}	12.81W	
Overheads	12.81W	
Total	25.6W	

First Technology Demonstration: Large Scale Antenna Array Systems, Using MIMO to Focus RF Energy

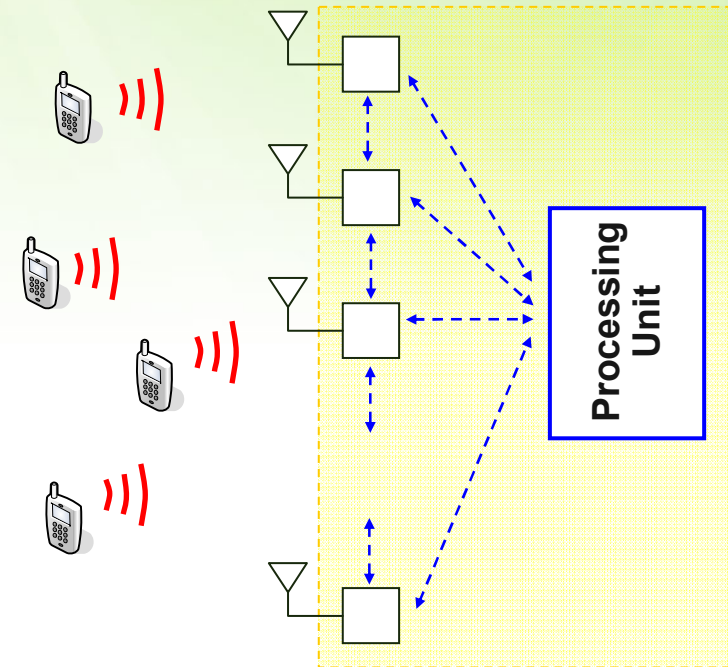

Marzetta, T. L., IEEE
Trans Wireless Comm,
Nov 2010

Current Antenna Technology

16 element antenna array

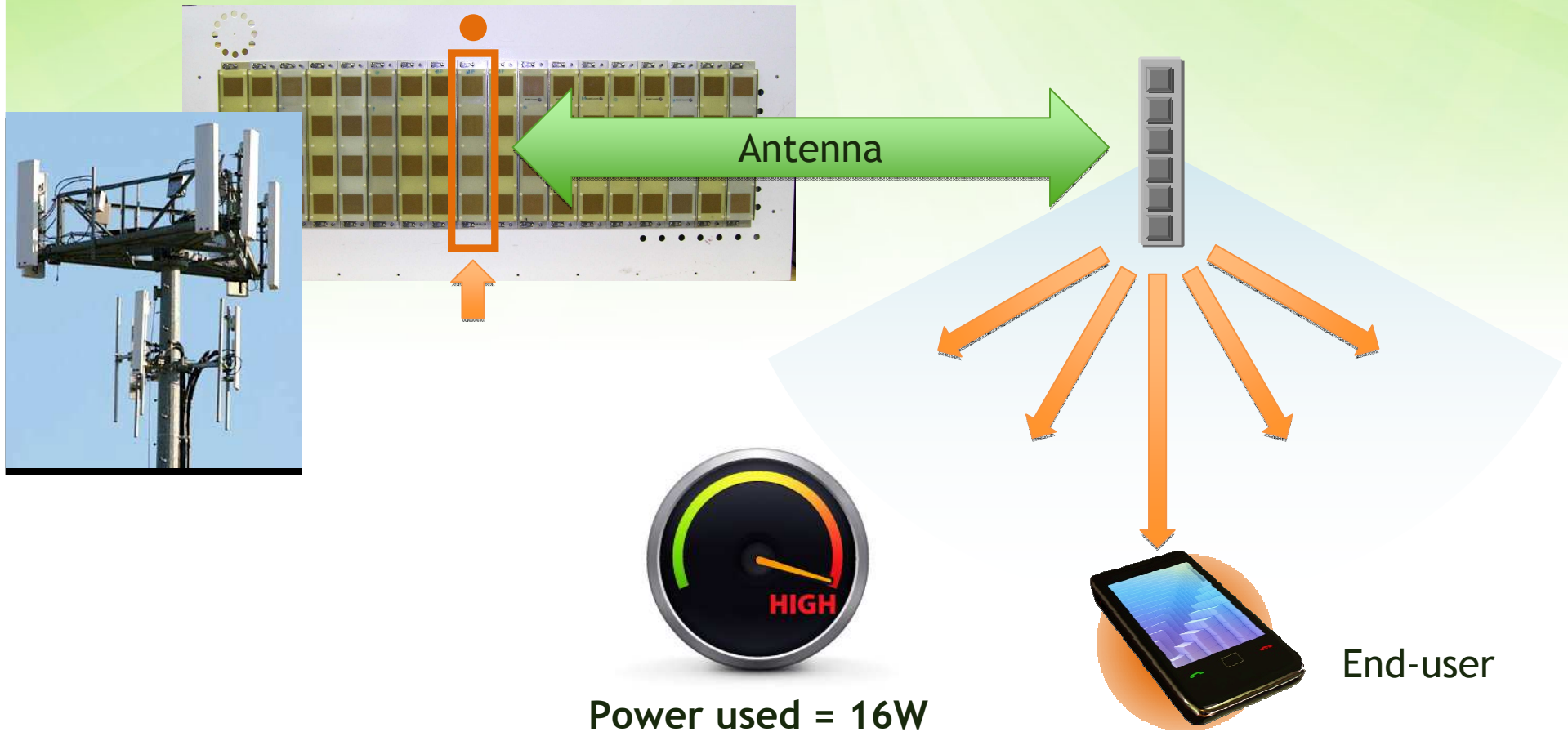

Large Scale Antenna System Demonstration

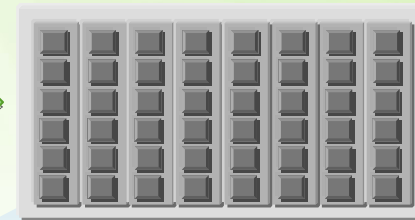
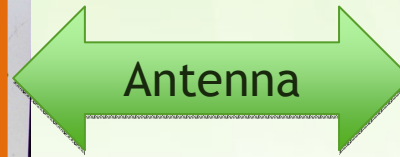
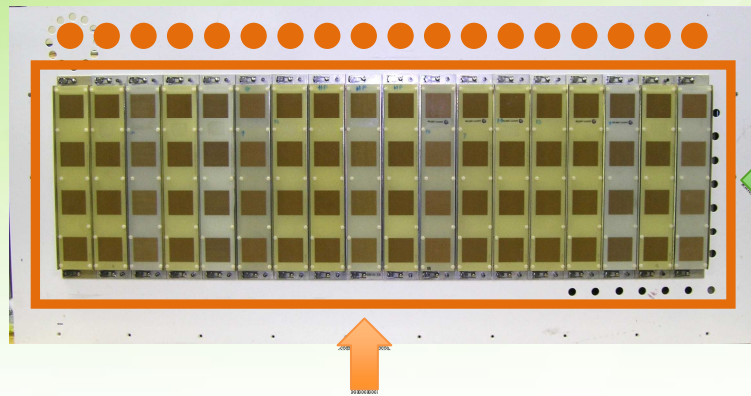

16 Antennas → 16x power reduction!

Collaborators:
Bell Labs
Freescale
Huawei
imec
Samsung



Power used = 1W

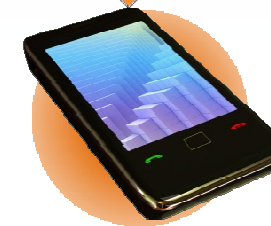

End-user

Beyond Cellular Mobile

Separating Data Network from Signaling Network

Data Network

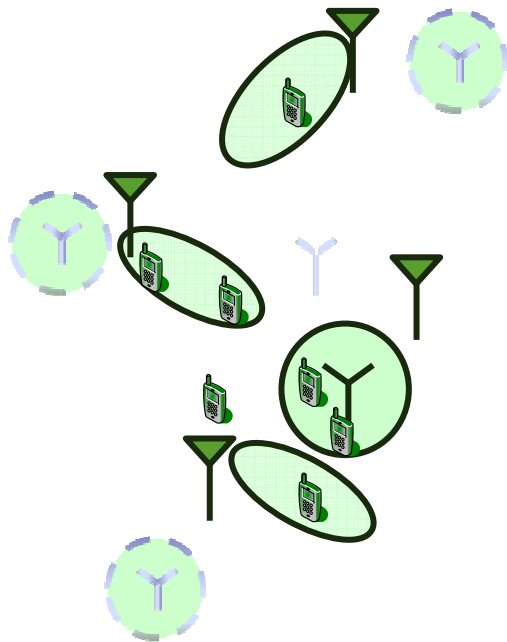

Signaling Network

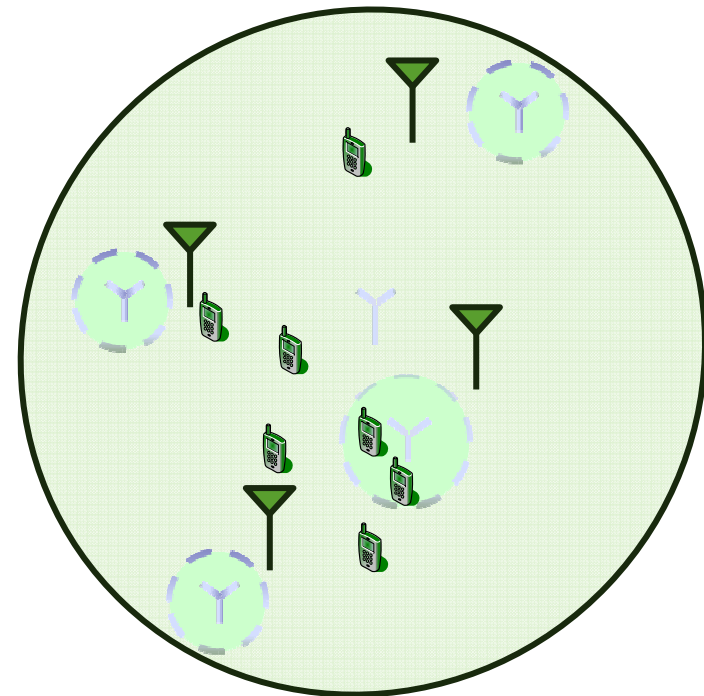

Collaborators:
Bell Labs
Huawei
Samsung
INRIA

Mobile Communications Working Group

Wireline Access

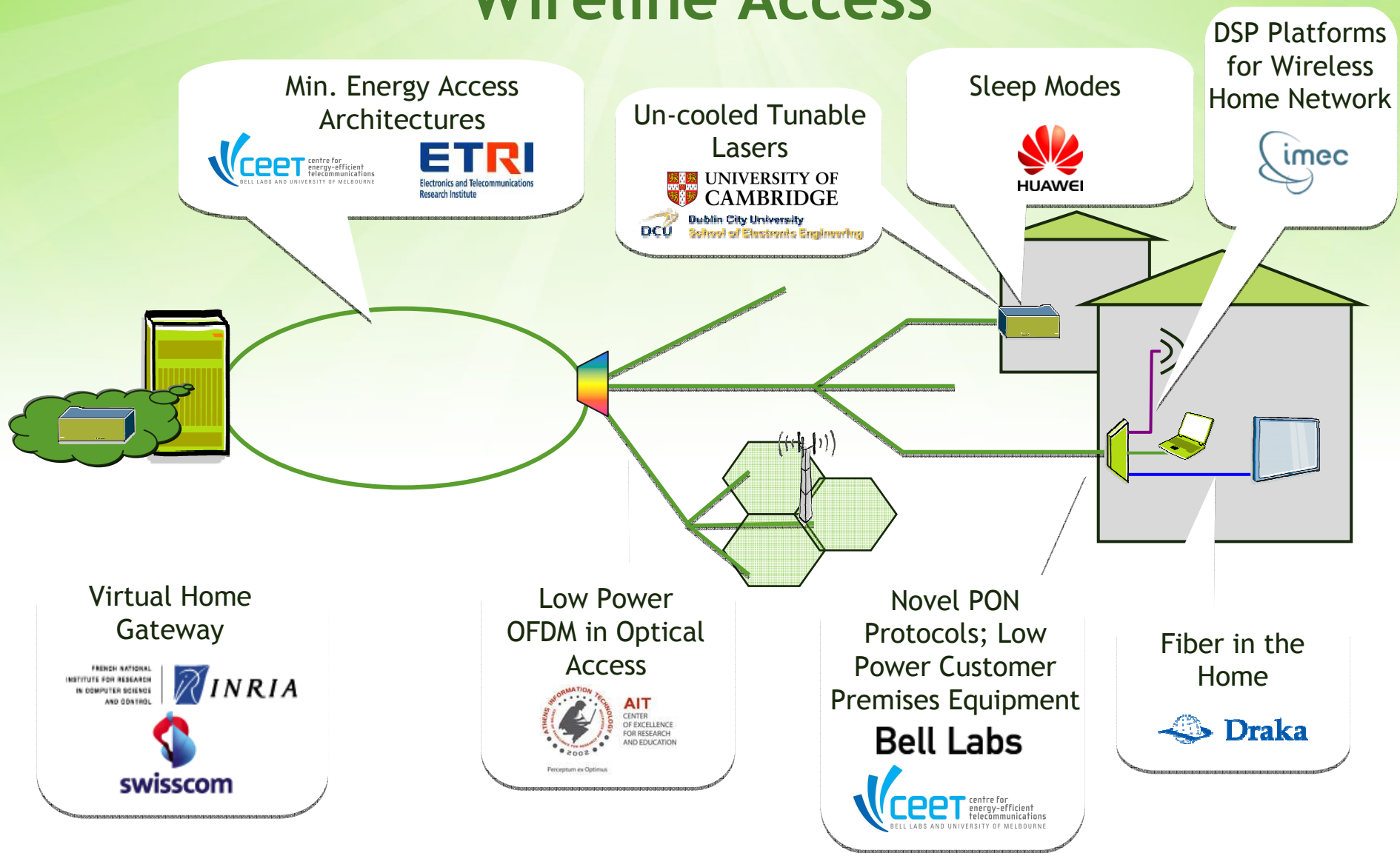

Single-Chip Router Linecards

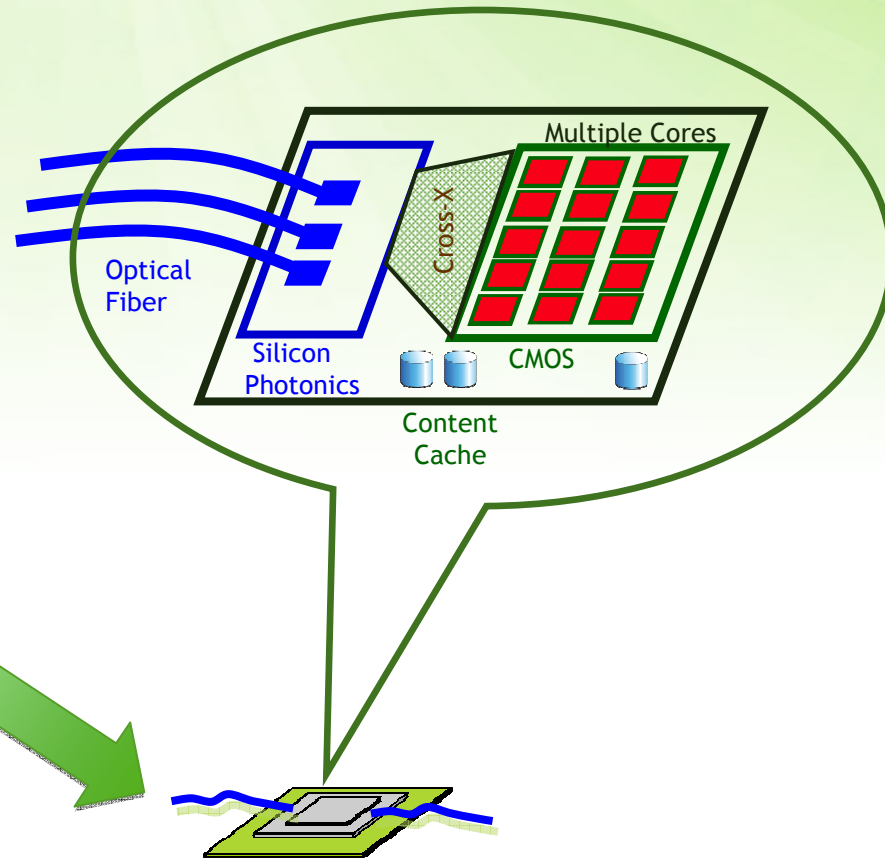
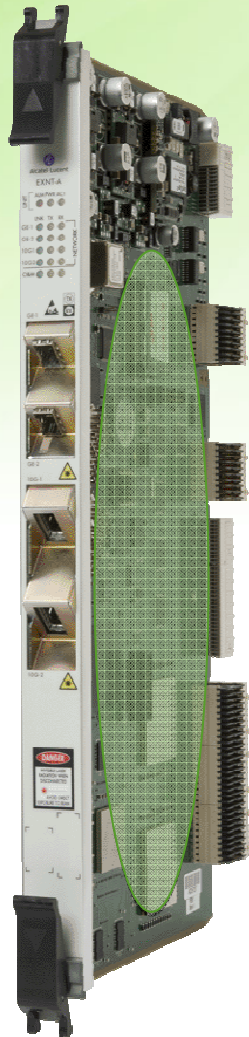

Hybrid Electronic - Photonic Chip

Core Switching & Routing Working Group

Cooperation Among Diverse Research Groups & Consortia

- Cooperating Project INTERNET: INTelligent Energy awaRe NETworks

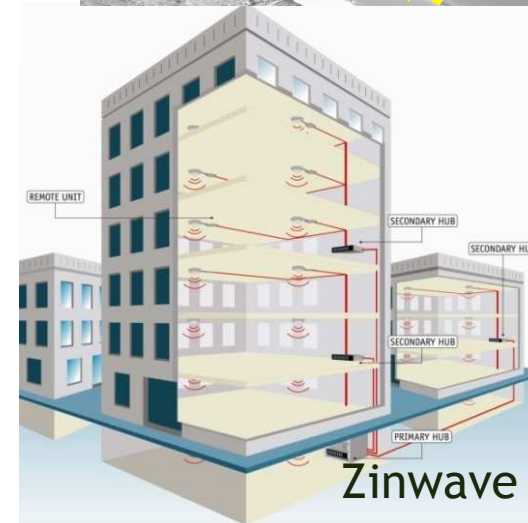
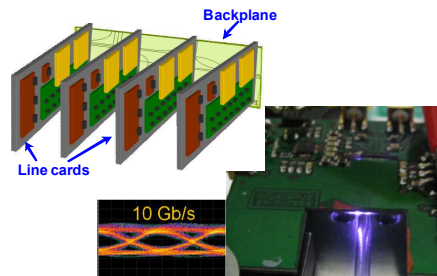
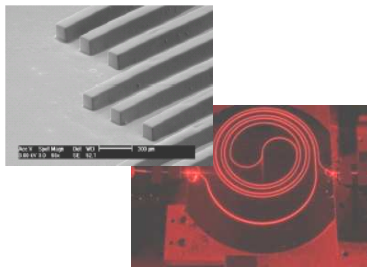
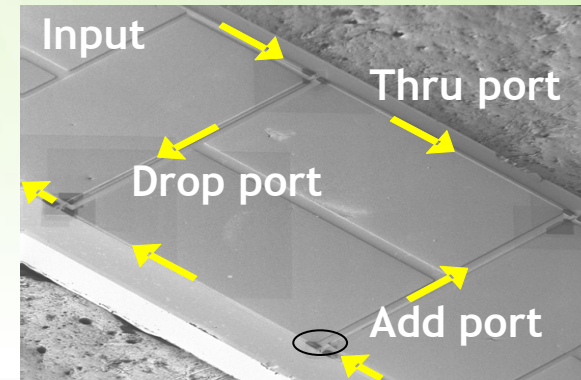
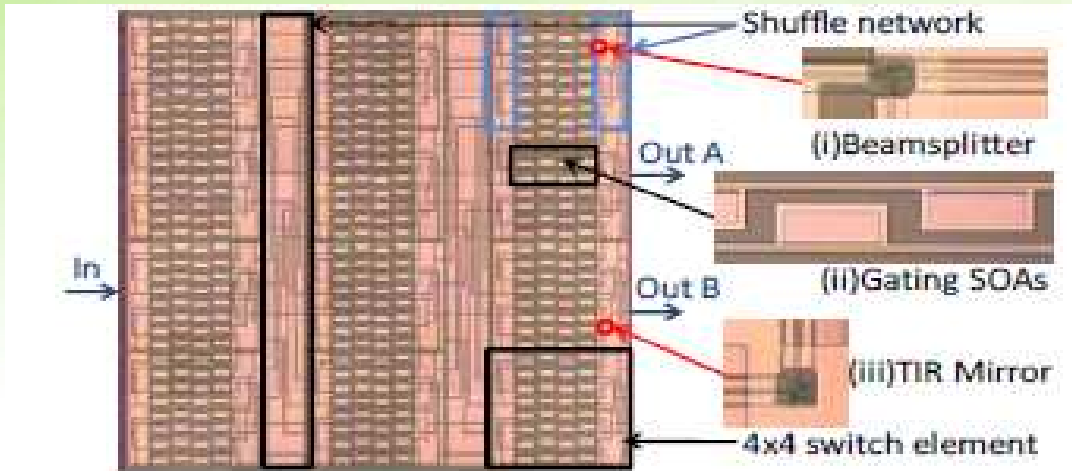

UNIVERSITY OF CAMBRIDGE

Conclusions

- **Eco-sustainability is crucial for ICT**
 - Networks are key part of overall social strategy to reduce carbon footprint
 - Essential tool in realizing sustainable living
 - Benefit must be reconciled against network growth
- **Scaling networks is becoming harder**
 - Cannot rely on semiconductors alone
 - The industry just doesn't have a current solution
- **Understanding energy use in networks is a complex**
 - Many trade-offs to be considered
 - Potential for large efficiency improvements from task specific design
 - Integration is essential for minimizing common equipment energy
 - Focus shifting to components, systems, & networks

Thank You

GreenTouch™
www.greentouch.org

